

IEC Appliance Inlet C14 with Filter, Fuseholder 1- or 2-pole (5x20 mm or 6.3x32 mm), Line Switch 1- or 2-pole, Voltage Selector (Step)



See below:
[Approvals and Compliances](#)

Description

- Panel mount :
Screw-on mounting front side
- 5 Functions :
Appliance Inlet , Line Switch , Fuseholder with interchangeable fuse drawer for Fuse-links 5x20 mm or 6.3x32 mm , with or without voltage selector (step switch) , Line filter in standard and medical version
- V-Lock notch standard
- Quick connect terminals 4.8 x 0.8 mm

Unique Selling Proposition

- Multifunctional Power Entry Module
- Solid metal flange
- Various fuse drawers
- Slim design

Technical Data

Ratings IEC	1 - 10A @ Ta 40 °C / 250 VAC; 50Hz
Ratings UL/CSA	1 - 10A @ Ta 40 °C / 250 VAC; 60Hz
Leakage Current	standard < 0.5 mA (250 V / 60 Hz) medical < 5 µA (250 V / 60 Hz)
Dielectric Strength	> 1.7 kVDC between L-N > 2.7 kVDC between L/N-PE Test voltage (2 sec)
Allowable Operation Temperature	-25 °C to 85 °C
Climatic Category	25/085/21 acc. to IEC 60068-1
IP-Protection	front side IP40 acc. to IEC 60529
Protection Class	Suitable for appliances with protection class I acc. to IEC 61140
Terminal	Quick connect terminals 4.8 x 0.8 mm
Panel Thickness S	Screw: max 8 mm Mounting screw torque max 0.5 Nm
Material: Housing	Thermoplastic, black, UL 94V-0

Characteristics

- All single elements are already wired
- The fuse drawer "Fingergrip" can be removed by hand
- For applications according IEC/UL 62368-1 we recommend variants with bleed resistor
- Suitable for use in medical equipment according to IEC/UL 60601-1

References

Alternative: version without line filter [KD](#)

Weblinks

[pdf data sheet](#), [html datasheet](#), [General Product Information](#), [Approvals](#), [Distributor-Stock-Check](#), [Accessories](#), [Detailed request for product](#)

Appliance inlet/-outlet	C14 acc. to IEC 60320-1, UL 498, CSA C22.2 no. 42 (for cold conditions) pin-temperature 70 °C, 10A, Protection Class I
Fuseholder	1-/2-pole, Shocksafe category PC2 acc. to IEC 60127-6, for fuse-links 5 x 20 / 6.3 x 32 mm
Rated Power Acceptance @ Ta 23 °C	5 x 20: 2.5W (1 pole)/ 2W (2-pole) per pole 6.3 x 32: 3.15W (1 pole)/ 2.5W (2-pole) per pole
Power Acceptance @ Ta > 23°C	Admissible power acceptance at higher ambient temperature see derating curves
Line Switch	2-pole, non-illuminated, acc. to IEC 61058-1 Technical Details
Voltage Selector	optional, step, 2-4 digits
Line Filter	Standard and Medical Version, IEC 60939, UL 1283, CSA C22.2 no. 8 Technical Details
MTBF	> 1'200'000h acc. to MIL-HB-217 F

Approvals and Compliances



Detailed information on product approvals, code requirements, usage instructions and detailed test conditions can be looked up in [Details about Approvals](#)

SCHURTER products are designed for use in industrial environments. They have approvals from independent testing bodies according to national and international standards. Products with specific characteristics and requirements such as required in the automotive sector according to IATF 16949, medical technology according to ISO 13485 or in the aerospace industry can be offered exclusively with customer-specific, individual agreements by SCHURTER.

Approvals









The approval mark is used by the testing authorities to certify compliance with the safety requirements placed on electronic products.

Approval Reference Type: CD

Approval Logo	Certificates	Certification Body	Description
	VDE Approvals	VDE	Certificate Number: 40004665 (FKSO, FKSP, FKSU, FKSV)
	UL Approvals	UL	UL File Number: E72928 (FKSO, FKSP, FKSU, FKSV)



Product standards

Product standards that are referenced

Organization	Design	Standard	Description
	Designed according to	IEC 60320-1	Appliance couplers for household and similar general purposes
	Designed according to	IEC 60939	Passive filters for suppressing electromagnetic interference
	Designed according to	IEC 60127-6	Miniature fuses. Part 6. Fuse-holders for miniature fuse-links
	Designed according to	IEC 61058-1	Switches for appliances. Part 1. General requirements
	Designed according to	UL 498	Standard for Attachment Plugs and Receptacles
	Designed according to	UL 1283	Electromagnetic interference filters
	Designed according to	CSA C22.2 no. 42	General Use Receptacles, Attachment Plugs, and Similar Wiring Devices
	Designed according to	CSA C22.2 no. 8	Electromagnetic interference (EMI) filters







Application standards

Application standards where the product can be used

Organization	Design	Standard	Description
	Designed for applications acc.	IEC/UL 62368-1	IEC 62368-1 includes the basic requirements for safety of audio, video, information technology and office equipment.
	Designed for applications acc.	IEC 60601-1	Medical electrical equipment - Part 1: General requirements for basic safety and essential performance
	Designed for applications acc.	IEC 60335-1	Safety of electrical appliances for household and similar purposes. Meets the requirements for appliances in unattended use. This includes the enhanced requirements of glow wire tests acc. to IEC 60695-2-11 or -12 & -13.

Compliances

The product complies with following Guide Lines

Identification	Details	Initiator	Description
	CE declaration of conformity	SCHURTER AG	The CE marking declares that the product complies with the applicable requirements laid down in the harmonisation of Community legislation on its affixing in accordance with EU Regulation 765/2008.
	RoHS	SCHURTER AG	Directive RoHS 2011/65/EU, Amendment (EU) 2015/863
	China RoHS	SCHURTER AG	The law SJ / T 11363-2006 (China RoHS) has been in force since 1 March 2007. It is similar to the EU directive RoHS.
	REACH	SCHURTER AG	On 1 June 2007, Regulation (EC) No 1907/2006 on the Registration, Evaluation, Authorization and Restriction of Chemicals 1 (abbreviated as "REACH") entered into force.
		SCHURTER AG	V-Lock system are based on a matching plug-dose combination. The connector is equipped with a notch intended for use with the latching cordset. The cord latching system prevents against accidental removal of the cordset.
	White Paper Glow wire test	SCHURTER AG	Meets the requirements of IEC 60335-1 for appliances in unattended use. This includes the enhanced requirements of glow wire tests acc. to IEC 60695-2-11 or -12 & -13.
	Medical Equipment	SCHURTER AG	Suitable for use in medical equipment according to IEC/UL 60601-1

Dimension [mm]
 CD

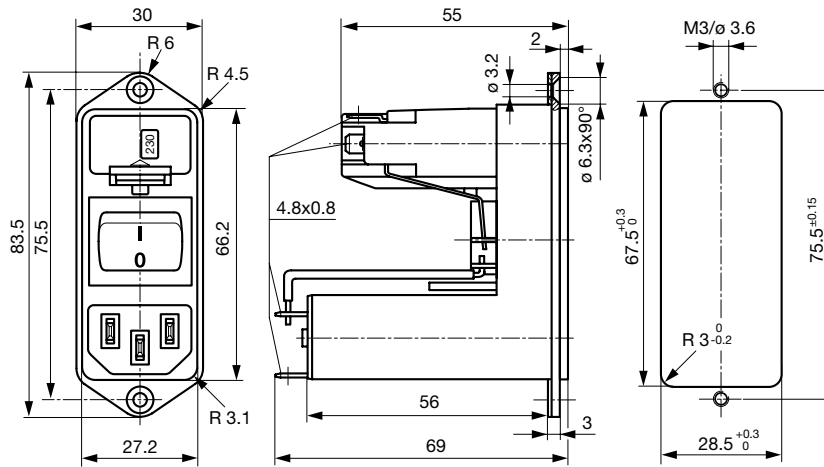

Technical Data of Filter-Components

Rated Current [A]	Filter-Type	Inductances L [mH]	Capacitance CX [nF]	Capacitance CY [nF]	R [MΩ]
1	Standard version	2 x 10	68	2.2	-
2	Standard version	2 x 4	68	2.2	-
4	Standard version	2 x 1.5	68	2.2	-
6	Standard version	2 x 0.8	68	2.2	-
10	Standard version	2 x 0.3	68	2.2	-
1	Medical Version (M5)	2 x 10	68	-	1
2	Medical Version (M5)	2 x 4	68	-	1
4	Medical Version (M5)	2 x 1.5	68	-	1
6	Medical Version (M5)	2 x 0.8	68	-	1
10	Medical Version (M5)	2 x 0.3	68	-	1
2	Medical Version (M80)	2 x 4	68	0.47	1
4	Medical Version (M80)	2 x 1.5	68	0.47	1
10	Medical Version (M80)	2 x 0.3	68	0.47	1

Diagrams

Standard version

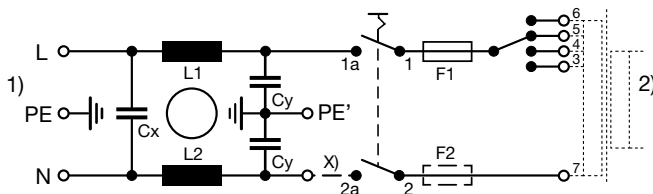

- 1) Line
- 2) Load
- x) External connection to be made by the customer

Medical Version (M5)

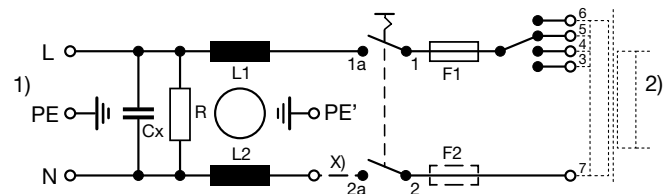

- 1) Line
- 2) Load
- x) External connection to be made by the customer

Derating Curves

Fuses

5 x 20 mm (1-pole)

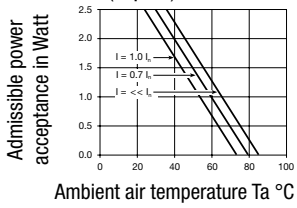

Fuses

5 x 20 mm (2-pole, per pole)

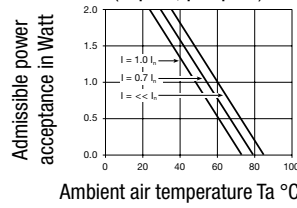

Fuses

6.3 x 32 mm (1-pole)

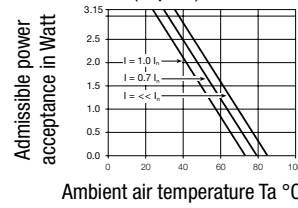

Fuses

6.3 x 32 mm (2-pole, per pole)

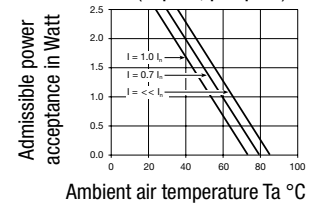

Attenuation Loss

--- 50Ω differential mode ___ 50Ω common mode

Standard version

1 A

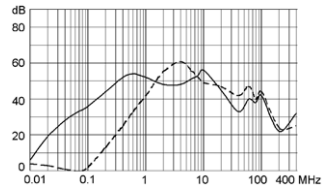

2 A

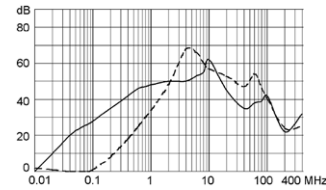

4 A

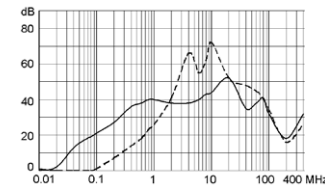

6 A

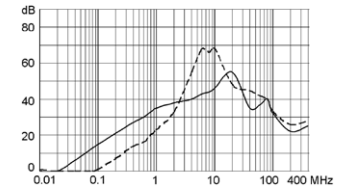

10 A

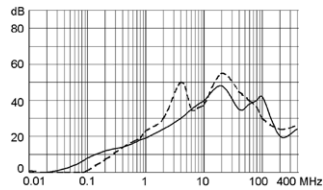

Medical version (M5)

1 A

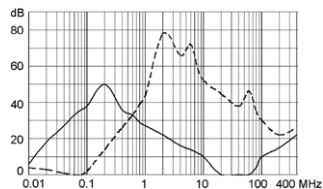

2 A

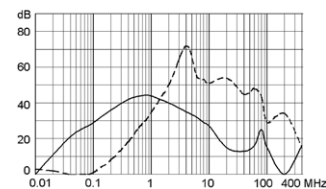

4 A

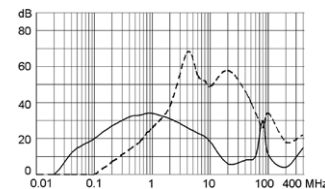

6 A

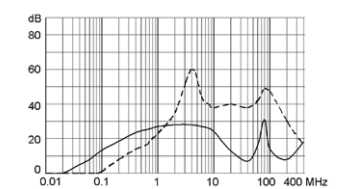

10 A

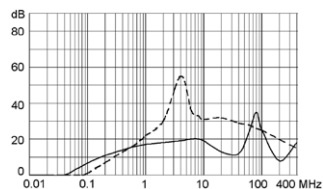

All Variants

Type	Rated Current [A]	Filter-Type	Fuseholder	Line Switch	Voltage Selector	V-Lock	Order Number
CD	1	Standard version	1-pole	2-pole	-	●	CD11.1501.151
CD	2	Standard version	1-pole	2-pole	-	●	CD21.1501.151
CD	4	Standard version	1-pole	2-pole	-	●	CD31.1501.151
CD	6	Standard version	1-pole	2-pole	-	●	CD41.1501.151

Type	Rated Current [A]	Filter-Type	Fuseholder	Line Switch	Voltage Selector	V-Lock	Order Number
CD	10	Standard version	1-pole	2-pole	-	●	CD61.1501.151
CD	1	Standard version	1-pole	2-pole	2-4 digits	●	CD11.4501.151
CD	2	Standard version	1-pole	2-pole	2-4 digits	●	CD21.4501.151
CD	4	Standard version	1-pole	2-pole	2-4 digits	●	CD31.4501.151
CD	6	Standard version	1-pole	2-pole	2-4 digits	●	CD41.4501.151
CD	10	Standard version	1-pole	2-pole	2-4 digits	●	CD61.4501.151
CD	1	Standard version	2-pole	2-pole	-	●	CD14.1101.151
CD	2	Standard version	2-pole	2-pole	-	●	CD24.1101.151
CD	4	Standard version	2-pole	2-pole	-	●	CD34.1101.151
CD	6	Standard version	2-pole	2-pole	-	●	CD44.1101.151
CD	10	Standard version	2-pole	2-pole	-	●	CD64.1101.151
CD	1	Standard version	2-pole	2-pole	2-4 digits	●	CD14.4101.151
CD	2	Standard version	2-pole	2-pole	2-4 digits	●	CD24.4101.151
CD	4	Standard version	2-pole	2-pole	2-4 digits	●	CD34.4101.151
CD	6	Standard version	2-pole	2-pole	2-4 digits	●	CD44.4101.151
CD	10	Standard version	2-pole	2-pole	2-4 digits	●	CD64.4101.151
CD	6	Medical Version (M5)	2-pole	2-pole	-	●	CDE4.1101.151
CD	1	Medical Version (M5)	2-pole	2-pole	2-4 digits	●	CDG4.4101.151
CD	2	Medical Version (M5)	2-pole	2-pole	2-4 digits	●	CDA4.4101.151
CD	4	Medical Version (M5)	2-pole	2-pole	2-4 digits	●	CDC4.4101.151
CD	6	Medical Version (M5)	2-pole	2-pole	2-4 digits	●	CDE4.4101.151
CD	10	Medical Version (M5)	2-pole	2-pole	2-4 digits	●	CDL4.4101.151
CD	2	Medical Version (M80)	2-pole	2-pole	2-4 digits	●	CDB4.4101.151
CD	4	Medical Version (M80)	2-pole	2-pole	2-4 digits	●	CDD4.4101.151
CD	10	Medical Version (M80)	2-pole	2-pole	2-4 digits	●	CDM4.4101.151

Most Popular.

Availability for all products can be searched real-time: <https://www.schurter.com/en/Stock-Check/Stock-Check-SCHURTER>

The fuse drawer is not included and must be ordered separately (see required accessory).

Packaging unit

10 Pcs

Required Accessory

Description

Fusedrawer 3

Fusedrawer for Fuse Links 5x20 mm resp. 6.3x32 mm



Fingergrip, 5 x 20, 2-pole, Voltage Selector	4303.2014.00
Fingergrip, 5 x 20, 2-pole, Voltage Selector, 100, 120, 220, 240	4303.2014.01
Fingergrip, 5 x 20, 2-pole, Voltage Selector, 110, 150, 220	4303.2014.02
Fingergrip, 5 x 20, 2-pole, Voltage Selector, 110, 220	4303.2014.03
...	...

Accessories



Wire Harness
 Wire harness for SCHURTER products



Assorted Covers
 Rear Cover

0859.0077



RC320
 Rear Cover for Power Entry Module



Cord retaining kits
 Cord retaining strain relief

Flat head, A 4700.0001

Mating Outlets/Connectors

Category / Description

[Appliance Outlet Overview complete](#)



4787, Mounting: Screw-on mounting, Appliance Outlet: IEC Solder terminals, 10 A, Suitable for appliances with protection class I	4787
4788, Mounting: Snap-in version, Appliance Outlet: IEC Solder / Quick Connect, 10 A, Suitable for appliances with protection class I	4788
IEC Appliance Outlet F or H, Screw-on Mounting, Front Side, Solder, PCB or Quick-connect Terminal	5091

[Connector Overview complete](#)



4782 Mounting: Power Cord, 3 x 1 mm ² / 3 x 18 AWG, Cable, Connector: IEC C13	4782
4785 Mounting: Power Cord, 3 x 1 mm ² / 3 x 18 AWG, Cable, Connector: IEC C13	4785
4300-06 Mounting: Power Cord, 3 x 1 mm ² / 3 x 18 AWG, Cable, Connector: IEC C13	4300-06
4781 Mounting: Power Cord, Cable, Connector: IEC C15	4781
4784 Mounting: Power Cord, 3 x 1 mm ² / 3 x 18 AWG, Cable, Connector: IEC C15	4784

...

Mating Outlets/Connectors shuttered



[Connector Overview complete](#)

4783 Mounting: Power Cord, 3 x 1 mm² / 3 x 18 AWG, Cable, Connector: IEC C13

[4783](#)



[Power Cord Overview complete](#)

VAC13KS, Overview, V-Lock cord retaining, diverse Connector IEC C13, diverse, black

[VAC13KS](#)